

Specification Sheet

.027 x 11 3/4" – Gutter Coil

.027 x 11 7/8" – Gutter Coil

5K .027" Aluminum Gutter

Listed below are the specifications on the paint, metal preparation, and finished coating for aluminum gutter coil.

- The aluminum used is alloy 3105-H24 which meets the specifications set forth in the "Aluminum Standards and Data 1988" published by the Aluminum Association. The gauge of the aluminum for the gutter is .027, plus or minus .002.
- The surface of the aluminum sheet is thoroughly cleaned and dried to remove residual oils and impurities using a 140°F-160°F hot water solution of potassium hydroxide provided by Henkel Surface Technologies and then applying a chromate or titanium base conversion coating, 1402W or 1455SF by Henkel Surface Technologies.
- A thermo setting polyester enamel is roller coated and baked at high temperatures for the outside coating. The reverse side of the coil, or wash coat, is a thermo setting polyester enamel applied to help resist corrosion and promote formability.
- The color range of the applied finish is .8 mils, plus or minus .2 mils (1.0)
- Made in the USA
- The physical test used on our coated panels includes:

180 degree-2T bend flex test no tape off using Scotch Brand #610 tape (ASTM D-4145-83)

Reverse impact –2 lbs./mil no tape off in positive direction using Scotch Brand #610 tape  
(ASTM D-4146-83)

Pencil Hardness-F minimum using Eagle Turquoise Brand pencil (ASTM D-3363-92A)

M.E.K. resistance - 100 double rubs using cheesecloth-mesh size 28 x 24 (ASTM D-5402-92)

Dry Heat flexibility – no tape off on 2T bend after 2minutes at 160 degrees F

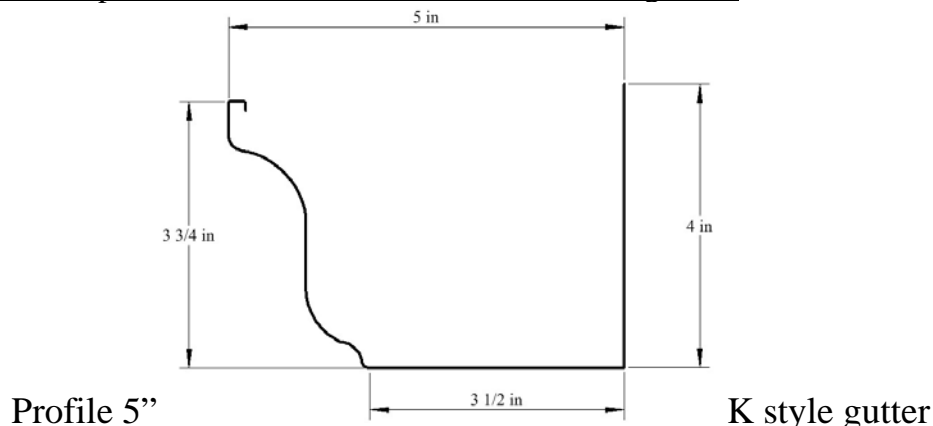

Specification Sheet

**.032 x 11 3/4" – Aluminum Gutter Coil  
5K Aluminum Gutter**

Listed below are the specifications on the paint, metal preparation, and finished coating for aluminum gutter coil.

- The aluminum used is alloy 3105-H24 which meets the specifications set forth in the "Aluminum Standards and Data 1988" published by the Aluminum Association. The gauge of the aluminum for the gutter is .032, plus or minus .002.
- The surface of the aluminum sheet is thoroughly cleaned and dried to remove residual oils and impurities using a 140°F-160°F hot water solution of potassium hydroxide provided by Henkel Surface Technologies and then applying a chromate or titanium base conversion coating, 1402W or 1455SF by Henkel Surface Technologies.
- A thermo setting polyester enamel is roller coated and baked at high temperatures for the outside coating. The reverse side of the coil, or wash coat, is a thermo setting polyester enamel applied to help resist corrosion and promote formability.
- The color range of the applied finish is .8 mils, plus or minus .2 mils (1.0)
- Made in the USA
- The physical test used on our coated panels includes:

180 degree-2T bend flex test no tape off using Scotch Brand #610 tape (ASTM D-4145-83)

Reverse impact –2 lbs./mil no tape off in positive direction using Scotch Brand #610 tape (ASTM D-4146-83)

Pencil Hardness-F minimum using Eagle Turquoise Brand pencil (ASTM D-3363-92A)

M.E.K. resistance - 100 double rubs using cheesecloth-mesh size 28 x 24 (ASTM D-5402-92)

Dry Heat flexibility – no tape off on 2T bend after 2minutes at 160 degrees F

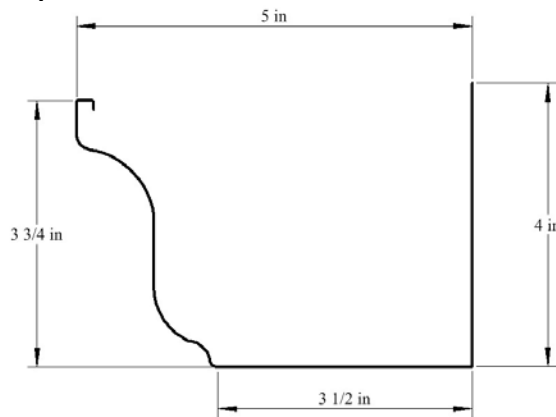

**Profile 5"**

**K style gutter**

Specification Sheet

.027 x 15" – Aluminum Gutter Coil  
6K Aluminum Gutter

Listed below are the specifications on the paint, metal preparation, and finished coating for aluminum gutter coil.

- The aluminum used is alloy 3105-H24 which meets the specifications set forth in the "Aluminum Standards and Data 1988" published by the Aluminum Association. The gauge of the aluminum for the gutter is .027, plus or minus .002.
- The surface of the aluminum sheet is thoroughly cleaned and dried to remove residual oils and impurities using a 140°F-160°F hot water solution of potassium hydroxide provided by Henkel Surface Technologies and then applying a chromate or titanium base conversion coating, 1402W or 1455SF by Henkel Surface Technologies
- A thermo setting polyester enamel is roller coated and baked at high temperatures for the outside coating. The reverse side of the coil, or wash coat, is a thermo setting polyester enamel applied to help resist corrosion and promote formability.
- The color range of the applied finish is .8 mils, plus or minus .1 mils (.7-.9)
- Made in the USA
- The physical test used on our coated panels includes:
  - 180 degree-2T bend flex test no tape off using Scotch Brand #610 tape (ASTM D-4145-83)
  - Reverse impact –2 lbs./mil no tape off in positive direction using Scotch Brand #610 tape (ASTM D-4146-83)
  - Pencil Hardness-F minimum using Eagle Turquoise Brand pencil (ASTM D-3363-92A)
  - M.E.K. resistance - 100 double rubs using cheesecloth-mesh size 28 x 24 (ASTM D-5402-92)

Dry Heat flexibility – no tape off on 2T bend after 2minutes at 160 degrees F

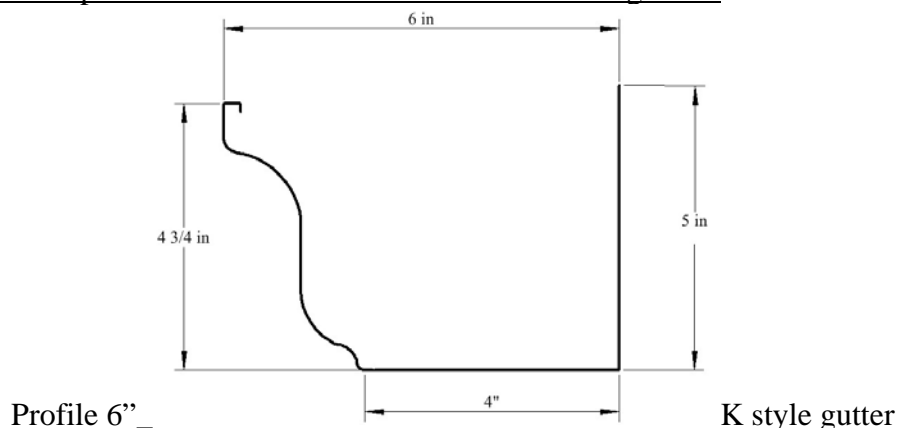

## Specification Sheet

### .032 x 15" – Aluminum Gutter Coil 6K Aluminum Gutter

Listed below are the specifications on the paint, metal preparation, and finished coating for aluminum gutter coil.

- The aluminum used is alloy 3105-H24 which meets the specifications set forth in the "Aluminum Standards and Data 1988" published by the Aluminum Association. The gauge of the aluminum for the gutter is .032, plus or minus .002.
- The surface of the aluminum sheet is thoroughly cleaned and dried to remove residual oils and impurities using a 140°F-160°F hot water solution of potassium hydroxide provided by Henkel Surface Technologies and then applying a chromate or titanium base conversion coating, 1402W or 1455SF by Henkel Surface Technologies.
- A thermo setting polyester enamel is roller coated and baked at high temperatures for the outside coating. The reverse side of the coil, or wash coat, is a thermo setting polyester enamel applied to help resist corrosion and promote formability.
- The color range of the applied finish is .8 mils, plus or minus .1 mils (.7-.9)
- Made in the USA
- The physical test used on our coated panels includes:
  - 180 degree-2T bend flex test no tape off using Scotch Brand #610 tape (ASTM D-4145-83)
  - Reverse impact –2 lbs./mil no tape off in positive direction using Scotch Brand #610 tape (ASTM D-4146-83)
  - Pencil Hardness-F minimum using Eagle Turquoise Brand pencil (ASTM D-3363-92A)
  - M.E.K. resistance - 100 double rubs using cheesecloth-mesh size 28 x 24 (ASTM D-5402-92)
  - Dry Heat flexibility – no tape off on 2T bend after 2minutes at 160 degrees F 180 degree-2T tale, Scotch Brand #610

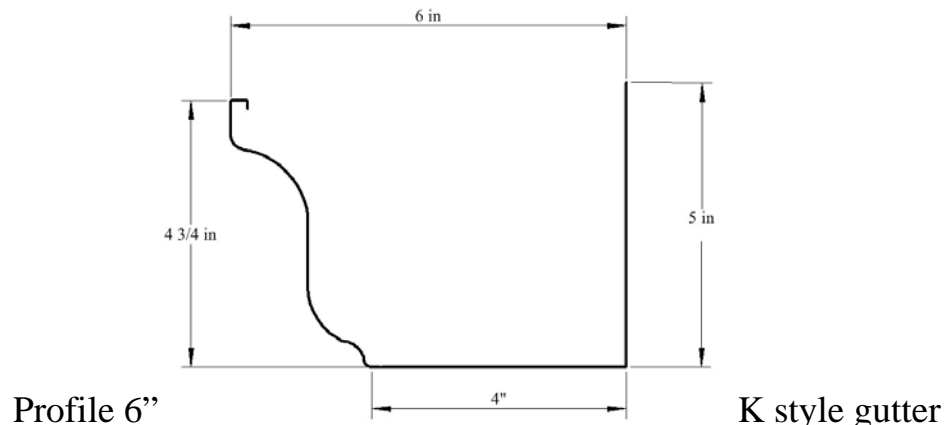



888-686-7737

<http://clintonseamlessguttering.com/>

### Specification Sheet

.027 x 11 3/4" – Aluminum Gutter Coil  
6" Half Round Aluminum Gutter

Listed below are the specifications on the paint, metal preparation, and finished coating for aluminum gutter coil.

- The aluminum used is alloy 3105-H24 which meets the specifications set forth in the “Aluminum Standards and Data 1988” published by the Aluminum Association. The gauge of the aluminum for the gutter is .027, plus or minus .002.
- The surface of the aluminum sheet is thoroughly cleaned and dried to remove residual oils and impurities using a 140°F-160°F hot water solution of potassium hydroxide provided by Henkel Surface Technologies and then applying a chromate or titanium base conversion coating, 1402W or 1455SF by Henkel Surface Technologies.
- A thermo setting polyester enamel is roller coated and baked at high temperatures for the outside coating. The reverse side of the coil, or wash coat, is a thermo setting polyester enamel applied to help resist corrosion and promote formability.
- The color range of the applied finish is .8 mils, plus or minus .2 mils (1.0)
- Made in the USA
- The physical test used on our coated panels includes:
  - 180 degree-2T bend flex test no tape off using Scotch Brand #610 tape (ASTM D-4145-83)
  - Reverse impact –2 lbs./mil no tape off in positive direction using Scotch Brand #610 tape (ASTM D-4146-83)
  - Pencil Hardness-F minimum using Eagle Turquoise Brand pencil (ASTM D-3363-92A)
  - M.E.K. resistance - 100 double rubs using cheesecloth-mesh size 28 x 24 (ASTM D-5402-92)

Dry Heat flexibility – no tape off on 2T bend after 2minutes at 160 degrees F

**Specification Sheet**

.019 x 10 ½" Aluminum Downspout Coil  
2" x 3" Aluminum Downspout

**Specifications on the paint, metal preparation, and finish coating for aluminum downspout coil:**

- The aluminum used is alloy 3105-H25 which meets the specifications set forth in the "Aluminum Standards and Data 1988" published by the Aluminum Association. The gauge of the aluminum for the pipe is .019, plus or minus .002.
- The surface of the aluminum sheet is thoroughly cleaned and dried to remove residual oils and impurities using a 140°F-160°F hot water solution of potassium hydroxide provided by Henkel Surface Technologies and then applying a chromate or titanium base conversion coating, 1402W or 1455SF by Henkel Surface Technologies
- A thermo setting polyester enamel is roller coated and baked at high temperatures for the outside coating. The reverse side of the coil, or wash coat, is a thermo setting polyester enamel applied to help resist corrosion and promote formability.
- The color range of the applied finish is .8 mils, plus or minus .2 mils. (1.0)
- The physical test used on our coated panels includes

180 degree-2T bend flex test no tape off using Scotch Brand #610 tape (ASTM D-4145-83)

Reverse impact –2 lbs./mil no tape off in positive direction using Scotch Brand #610 tape (ASTM D-4146-83)

Pencil Hardness-F minimum using Eagle Turquoise Brand pencil (ASTM D-3363-92A)

M.E.K. resistance - 100 double rubs using cheesecloth-mesh size 28 x 24 (ASTM D-5402-92)

Dry Heat flexibility – no tape off on 2T bend after 2minutes at 160 degrees F

**Specifications & features of the finished product:**

- The overall length is 10 or 15 feet, standard
- The pipe's opening is 2 x 3 inches nominal
- The pipe is corner crimped on one end for ease of assembly
- The finish of this product is covered by a 20 year limited warranty
- Made in the USA

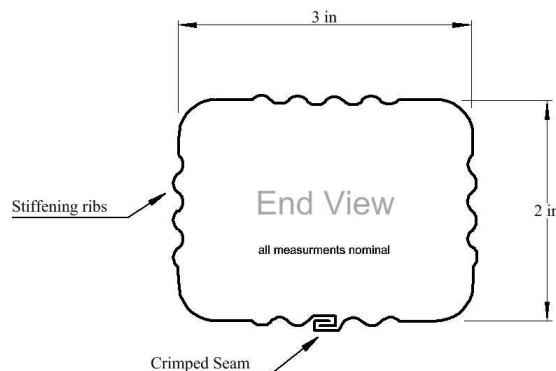

### Specification Sheet

.019 x 13 ¾" Aluminum Downspout Coil  
3"x 4" Aluminum Downspout

#### **Specifications on the paint, metal preparation, and finish coating for aluminum downpipe coil:**

- The aluminum used is alloy 3105-H25 which meets the specifications set forth in the "Aluminum Standards and Data 1988" published by the Aluminum Association. The gauge of the aluminum for the pipe is .019, plus or minus .002.
- The surface of the aluminum sheet is thoroughly cleaned and dried to remove residual oils and impurities using a 140°F-160°F hot water solution of potassium hydroxide provided by Henkel Surface Technologies and then applying a chromate or titanium base conversion coating, 1402W or 1455SF by Henkel Surface Technologies.
- A thermo setting polyester enamel is roller coated and baked at high temperatures for the outside coating. The reverse side of the coil, or wash coat, is a thermo setting polyester enamel applied to help resist corrosion and promote formability.
- The color range of the applied finish is .8 mils, plus or minus .2 mils. (1.0)
- The physical test used on our coated panels includes

180 degree-2T bend flex test no tape off using Scotch Brand #610 tape (ASTM D-4145-83)

Reverse impact -2 lbs./mil no tape off in positive direction using Scotch Brand #610 tape  
(ASTM D-4146-83)

Pencil Hardness-F minimum using Eagle Turquoise Brand pencil (ASTM D-3363-92A)

M.E.K. resistance - 100 double rubs using cheesecloth-mesh size 28 x 24 (ASTM D-5402-92)

Dry Heat flexibility - no tape off on 2T bend after 2minutes at 160 degrees F

#### **Specifications & features of the finished product:**

- The overall length is 10 or 15 feet, standard
- The pipe's opening is 2 ¾ x 4 inches
- The pipe is corner crimped on one end for ease of assembly
- The finish of this product is covered by a 20 year limited warranty
- Made in the USA

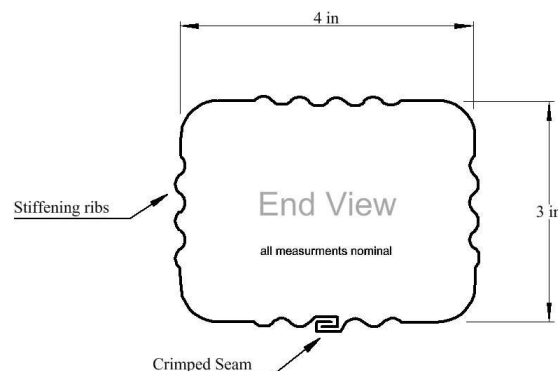

Specification Sheet

.027 x 13 ¾ " Aluminum Downspout Coil  
.024 x 13 x ¾ Aluminum Elbow Coil

**Specifications on the paint, metal preparation, and finish coating for aluminum downpipe coil:**

- The aluminum used is alloy 3105-H24 which meets the specifications set forth in the "Aluminum Standards and Data 1988" published by the Aluminum Association. The gauge of the aluminum for the pipe is .024, plus or minus .002.
- The surface of the aluminum sheet is thoroughly cleaned and dried to remove impurities and coated with Betz Metchum Permatreat 1500/3000 non-cyanide chromate conversion coating.
- A thermo setting polyester enamel is roller coated and baked at high temperatures for the outside coating. The reverse side of the coil, or wash coat, is a thermo setting polyester enamel applied to help resist corrosion.
- The color range of the applied finish is .8 mils, plus or minus .2 mils. (1.0)
- The physical test used on our coated panels includes
  - 180 degree- 2T tale, Scotch Brand #610
  - Reverse Impact- 2lbs./mil (positive tape) tape, Scotch Brand #610
  - Pencil Hardness-F minimum, Eagle Turquoise Brand
  - M.E.K.- 100 double rubs using cheesecloth-mesh size 28 x 24

**Specifications & features of the finished product:**

- The overall length is 10 or 15 feet, standard
- The pipe's opening is 2 ¾ x 4 inches
- The pipe is corner crimped on one end for ease of assembly
- The finish of this product is covered by a 20 year limited warranty
- Made in the USA

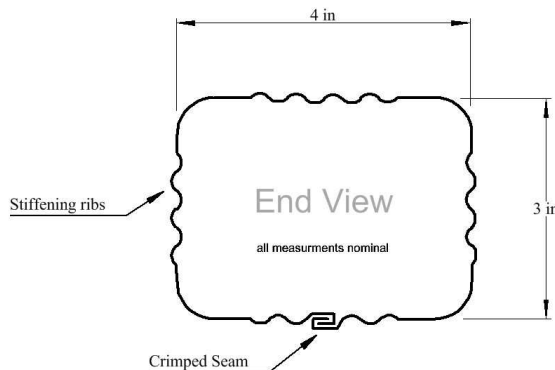



- Notes:
1. Blank width = 17.5625" ± .010 typ
  2. Surface shall be visually free from scratches, lines, spots or other imperfections.
  3. Seam shall be tight along the length of the product

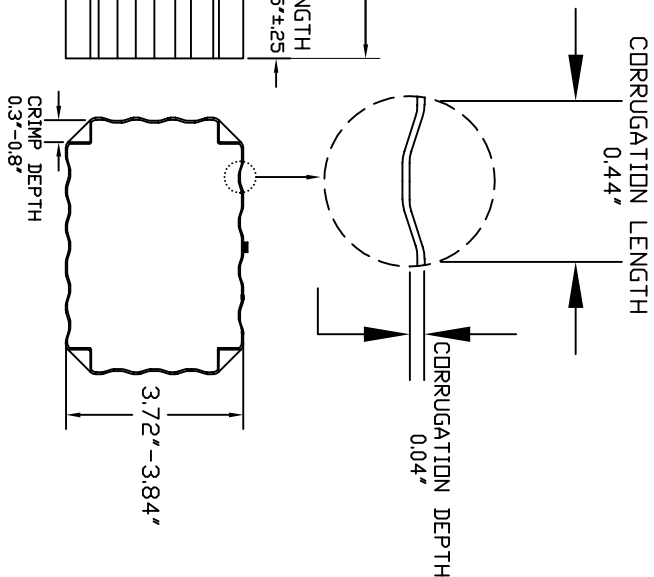
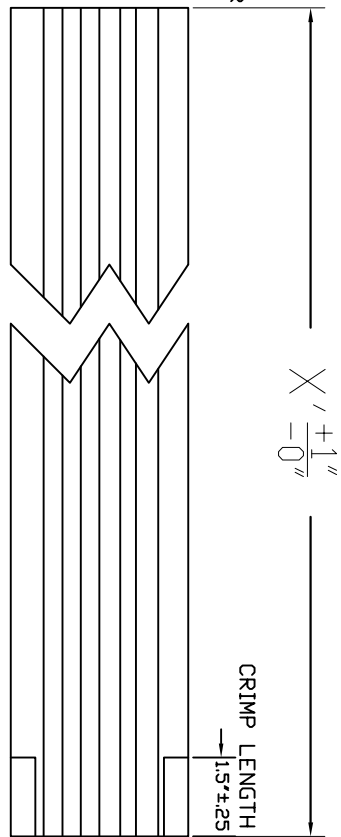
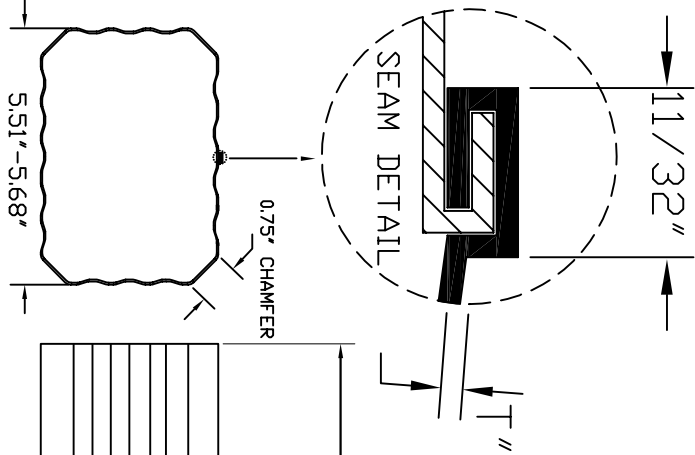

| MAT'L List    | 'T'-Thickness | MAT'L List  | 'T'-Thickness |
|---------------|---------------|-------------|---------------|
| GAL V 24      | 0.023         | LC 16oz CU  | 0.026         |
| GAL V 26      | 0.020         | BRVN ALUM   | 0.022         |
| GAL V 28      | 0.017         | DK BRZ ALUM | 0.022         |
| BRVN 26 STEEL | 0.020         | 80 WHT ALUM | 0.022         |
| WHT 26 STEEL  | 0.020         | MF ALUM     | 0.022         |
| PG GAL V 26   | 0.020         |             |               |
| S. STEEL      | 0.016         |             |               |
| 16oz COPPER   | 0.022         |             |               |
| 20oz COPPER   | 0.027         |             |               |

**General Tolerance**

X.X' =  $\pm \frac{1}{16}$   
 X.X'' =  $\pm 0.25$   
 X.X''' =  $\pm 0.003$   
 Bow/Warp =  $\frac{1}{4}$ " per 10ft  
 Twist =  $\frac{1}{8}$ " per 3 ft

Work Center = 104

Drawn By: Blake Holmes  
 DATE: 5/23/2006

| REVISIONS |     |             |      |          |
|-----------|-----|-------------|------|----------|
| ZONE      | REV | DESCRIPTION | DATE | APPROVED |
|           |     |             |      |          |

**BERGER**  
 Quality Building Products Since 1874

4x5 in. Square Corrugated  
 Pipe w/ Crimped End

|       |              |         |        |
|-------|--------------|---------|--------|
| SIZE  | FSCM NO.     | DWG NO. | REV    |
| A     |              | SPC-5   | -      |
| SCALE | not to scale | SHEET   | 1 OF 1 |

This drawing contains proprietary designs, specifications, and notes and is the property of Berger Building Products, Inc.. The information may be used solely for purposes designated by BBPI to evaluate tooling, part production, design feasibility or modification. It may not be used for any other purpose without permission of BBPI.

### Specification Sheet

.019 x 10 ½" Aluminum Elbow Coil  
2" x 3" Aluminum Elbow

#### **Specifications on the paint, metal preparation, and finish coating for aluminum elbow coil:**

- The aluminum used is alloy 3105-H25 which meets the specifications set forth in the "Aluminum Standards and Data 1988" published by the Aluminum Association. The gauge of the aluminum for the elbow is .019, plus or minus .002.
- The surface of the aluminum sheet is thoroughly cleaned and dried to remove residual oils and impurities using a 140°F-160°F hot water solution of potassium hydroxide provided by Henkel Surface Technologies and then applying a chromate or titanium base conversion coating, 1402W or 1455SF by Henkel Surface Technologies.
- A thermo setting polyester enamel is roller coated and baked at high temperatures for the outside coating. The reverse side of the coil, or wash coat, is a thermo setting polyester enamel applied to help resist corrosion and promote formability.
- The color range of the applied finish is .8 mils, plus or minus .2 mils. (1.0)
- The physical test used on our coated panels includes
  - 180 degree-2T bend flex test no tape off using Scotch Brand #610 tape (ASTM D-4145-83)
  - Reverse impact -2 lbs./mil no tape off in positive direction using Scotch Brand #610 tape (ASTM D-4146-83)
  - Pencil Hardness-F minimum using Eagle Turquoise Brand pencil (ASTM D-3363-92A)
  - M.E.K. resistance - 100 double rubs using cheesecloth-mesh size 28 x 24 (ASTM D-5402-92)
  - Dry Heat flexibility - no tape off on 2T bend after 2minutes at 160 degrees F

#### **Specifications & features of the finished product:**

- The overall length is 10 inches
- The elbow opening is 2 ¼ x 3 inches
- The elbow has 6 crimps resulting in a 75 degree bend
- The elbow is corner crimped for ease of assembly
- The finish of this product is covered by a 20 year limited warranty
- Made in the USA

### Specification Sheet

.019 x 13 ¾" Aluminum Elbow Coil  
3"x 4" Aluminum Elbow

#### **Specifications on the paint, metal preparation, and finish coating for aluminum elbow coil:**

- The aluminum used is alloy 3105-H25 which meets the specifications set forth in the "Aluminum Standards and Data 1988" published by the Aluminum Association. The gauge of the aluminum for the elbow is .019, plus or minus .002.
- The surface of the aluminum sheet is thoroughly cleaned and dried to remove residual oils and impurities using a 140°F-160°F hot water solution of potassium hydroxide provided by Henkel Surface Technologies and then applying a chromate or titanium base conversion coating, 1402W or 1455SF by Henkel Surface Technologies.
- A thermo setting polyester enamel is roller coated and baked at high temperatures for the outside coating. The reverse side of the coil, or wash coat, is a thermo setting polyester enamel applied to help resist corrosion and promote formability.
- The color range of the applied finish is .8 mils, plus or minus .2 mils. (1.0)
- The physical test used on our coated panels includes
  - 180 degree-2T bend flex test no tape off using Scotch Brand #610 tape (ASTM D-4145-83)
  - Reverse impact -2 lbs./mil no tape off in positive direction using Scotch Brand #610 tape (ASTM D-4146-83)
  - Pencil Hardness-F minimum using Eagle Turquoise Brand pencil (ASTM D-3363-92A)
  - M.E.K. resistance - 100 double rubs using cheesecloth-mesh size 28 x 24 (ASTM D-5402-92)
  - Dry Heat flexibility - no tape off on 2T bend after 2minutes at 160 degrees F

#### **Specifications & features of the finished product:**

- The overall length is 12 inches
- The elbow opening is 2 ¾ x 4 inches
- The elbow has 7 crimps resulting in a 75 degree bend
- The elbow is corner crimped for ease of assembly
- The finish of this product is covered by a 20 year limited warranty
- Made in the USA

### Specification Sheet

.019 x 13 1/8" Aluminum Downspout Coil  
4" Round Aluminum Downspout

#### **Specifications on the paint, metal preparation, and finish coating for aluminum downpipe coil:**

- The aluminum used is alloy 3105-H25 which meets the specifications set forth in the "Aluminum Standards and Data 1988" published by the Aluminum Association. The gauge of the aluminum for the pipe is .019, plus or minus .002.
- The surface of the aluminum sheet is thoroughly cleaned and dried to remove residual oils and impurities using a 140°F-160°F hot water solution of potassium hydroxide provided by Henkel Surface Technologies and then applying a chromate or titanium base conversion coating, 1402W or 1455SF by Henkel Surface Technologies..
- A thermo setting polyester enamel is roller coated and baked at high temperatures for the outside coating. The reverse side of the coil, or wash coat, is a thermo setting polyester enamel applied to help resist corrosion and promote formability.
- The color range of the applied finish is .8 mils, plus or minus .2 mils. (1.0)
- The physical test used on our coated panels includes
  - 180 degree-2T bend flex test no tape off using Scotch Brand #610 tape (ASTM D-4145-83)
  - Reverse impact -2 lbs./mil no tape off in positive direction using Scotch Brand #610 tape (ASTM D-4146-83)
  - Pencil Hardness-F minimum using Eagle Turquoise Brand pencil (ASTM D-3363-92A)
  - M.E.K. resistance - 100 double rubs using cheesecloth-mesh size 28 x 24 (ASTM D-5402-92)
  - Dry Heat flexibility - no tape off on 2T bend after 2minutes at 160 degrees F

#### **Specifications & features of the finished product:**

- The overall length is 10 feet, standard
- The pipe's opening is roughly 4" round
- The pipe is corner crimped on one end for ease of assembly
- The finish of this product is covered by a 20 year limited warranty
- Made in the USA

### Specification Sheet

.019 x 13 1/8" Aluminum Elbow Coil  
4" Round Aluminum Elbow

#### **Specifications on the paint, metal preparation, and finish coating for aluminum elbow coil:**

- The aluminum used is alloy 3105-H25 which meets the specifications set forth in the "Aluminum Standards and Data 1988" published by the Aluminum Association. The gauge of the aluminum for the elbow is .019, plus or minus .002.
- The surface of the aluminum sheet is thoroughly cleaned and dried to remove residual oils and impurities using a 140°F-160°F hot water solution of potassium hydroxide provided by Henkel Surface Technologies and then applying a chromate or titanium base conversion coating, 1402W or 1455SF by Henkel Surface Technologies.
- A thermo setting polyester enamel is roller coated and baked at high temperatures for the outside coating. The reverse side of the coil, or wash coat, is a thermo setting polyester enamel applied to help resist corrosion and promote formability.
- The color range of the applied finish is .8 mils, plus or minus .2 mils. (1.0)
- The physical test used on our coated panels includes
  - 180 degree-2T bend flex test no tape off using Scotch Brand #610 tape (ASTM D-4145-83)
  - Reverse impact -2 lbs./mil no tape off in positive direction using Scotch Brand #610 tape (ASTM D-4146-83)
  - Pencil Hardness-F minimum using Eagle Turquoise Brand pencil (ASTM D-3363-92A)
  - M.E.K. resistance - 100 double rubs using cheesecloth-mesh size 28 x 24 (ASTM D-5402-92)
  - Dry Heat flexibility - no tape off on 2T bend after 2minutes at 160 degrees F

#### **Specifications & features of the finished product:**

- The overall length is 13 1/2" inches
- The elbow opening is roughly 4" round
- The elbow has 10 crimps resulting in a 75 degree bend
- The elbow is corner crimped for ease of assembly
- The finish of this product is covered by a 20 year limited warranty
- Made in the USA